



WWW: A Brief History

Qiang Yang
Simon Fraser University

Thanks: Professors Francis Lau at HK Univ,
Dan Weld at UW-Seattle WA, Ethan Cerami,
New York University

The World Wide Web

- The "killer app" for the Internet
- "http://It has changed everything" (IEEE Spectrum, January 1997)
- The World Wide Web reaches a billion pages (Inktomi, 18 January 2000)
- Google:

Web Architecture

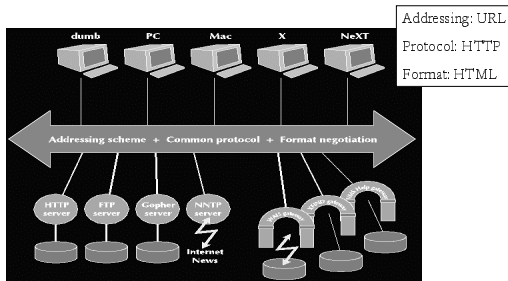

Architecture (cont'd)

The Web today

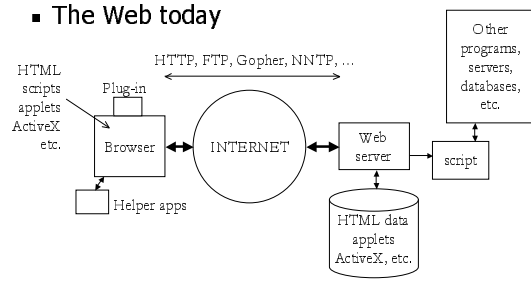

The Web Today

- Client-server
 - Browser the client, Web server the server
- Web servers listen for incoming requests and transmit the desired document back to the browser
- Web browsers are capable of running not only the HTTP protocol, but many other existing protocols such as FTP, Gopher, NNTP, WAIS, Telnet, SMTP, etc.

The Web Today (cont'd)

Defining "Web"

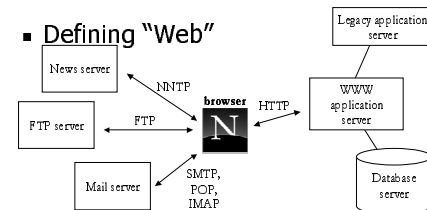

What is an World Wide Web Application?

- HTTP protocol
- HTML markup language
- Addressing: URL

1/7/01

SFU, CMPT 470

7

IP and the Internet

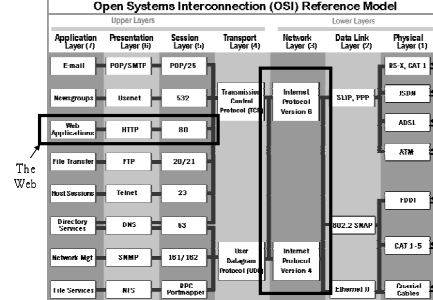

1/7/01

SFU, CMPT 470

8

Internet and WWW

- (The) Internet \neq (the) World Wide Web
- Referring to the previous picture, the Internet is made up of the first four to five layers
- The Web is only one of many applications that the Internet supports

1/7/01

SFU, CMPT 470

9

Different Kinds of Networks

- Local Area Network (LAN) - that spans a single building or campus
- Metropolitan Area Network (MAN) - that spans a single city
- Wide Area Network (WAN) - that spans sites in multiple cities, countries, or continents
- Global Area Network (GAN) - that spans the whole world, the Internet itself

Can you go beyond all these? What would you call it?

1/7/01

SFU, CMPT 470

10

Some Basic Terms

- Network
 - A (computer) network is a series of points or nodes interconnected by communication paths
 - Networks can interconnect with other networks (internetworks) and contain subnetworks (or subnets)

1/7/01

SFU, CMPT 470

11

Some Basic Terms (cont'd)

- Protocol
 - Formal description of a set of rules, conventions, and procedures that govern how devices on a network exchange information
- internet
 - An internetwork, with a small "i"
 - TCP/IP was the first set of protocols developed for use in an internet
 - It has since evolved into the *de facto* standard for internetworking

1/7/01

SFU, CMPT 470

12

The Internet

- An internetwork with a big "I"
 - The Internet is a global network of connected computer networks
 - The Internet is a global network of networks enabling computers of all kinds to directly and transparently communicate and share services throughout much of the world ([The official definition](#))
 - The Internet, sometimes called simply "the Net", is a worldwide system of computer networks – a network of networks in which users at any one computer can, if they have permission, get information from any other computer ([whatis.com](#))

1/7/01

SFU, CMPT 470

13

A Bit of History (the Major Events)

- 1945 - Vannevar Bush in an article entitled *As We May Think* discussed an information machine he called a **Memex**
- 1957
 - US forms the Advanced Research Projects Agency (ARPA) within the Department of Defense (DoD)
- 1961
 - L. Kleinrock of MIT proposes packet-switching
- 1965 - [Ted Nelson](#) self-published a book called **Literary Machines** in which he coined the term "*hypertext*"
- 1966
 - L.G. Roberts gives first ARPANET plan
- 1969
 - The ARPANET commissioned by DoD for research into networking; A four-node prototype is built

1/7/01

SFU, CMPT 470

14

History (cont'd)

- 1970
 - ALOHAnet, first packet radio (wireless) network, developed by the University of Hawaii, becomes operational
- 1971
 - A 15-node ARPANET running
 - R. Tomlinson invents email program
- 1972
 - The @ sign chosen for email addresses
 - First computer-to-computer chat program
 - Telnet specified

1/7/01

SFU, CMPT 470

15

History (cont'd)

- 1973
 - First international connection to the ARPANET
 - B. Metcalfe of Harvard outlines the idea for Ethernet; Ethernet operational at Xerox PARC
 - R. Kahn and V. Cerf present basic Internet ideas
 - FTP specified
- 1974
 - Cerf and Kahn publish detailed design of TCP
 - Intel launches 8080; TCP design
- 1976
 - UUCP (Unix-to-Unix CoPy) introduced
- 1978: TCP splits into TCP and IP

1/7/01

SFU, CMPT 470

16

History (cont'd)

- 1979
 - Usenet established using UUCP
 - K. MacKenzie suggests the use of emoticons ☺:-)
- 1981
 - Microsoft has 40 employees; IBM PC
 - BITNET (Because It's Time NETwork) started
 - CSNET (Computer Science NETwork)
- 1982
 - ARPANET uses TCP/IP as the protocol suite for its operation
 - "Internet" defined as connected TCP/IP
 - Sun formed

1/7/01

SFU, CMPT 470

17

History (cont'd)

- 1983 ARPANet uses TCP/IP -> birth of internet
- 1983
 - Name server developed
 - ARPANET splits into ARPANET and MILNET
 - Desktop workstations come into being, many running Berkeley UNIX with IP software
- 1984
 - Domain Name System (DNS) introduced
- 1985
 - "symbolic.com" becomes the first registered domain

1/7/01

SFU, CMPT 470

18

- 1986
 - NSFNET (National Science Foundation Network) with a backbone speed of 56 Kbps created
 - Network News Transfer Protocol (NNTP) designed to enhance Usenet news performance over TCP/IP
- 1988
 - Internet worm burrows through the Net, affection some 6,000 hosts
 - CERT (Computer Emergency Response Team) formed by DARPA
 - NSFNET upgraded to T1 (1.544 Mbps)

1/7/01 SFU, CMPT 470 19

- History (cont'd)
 - 1987 – Apple released the first commercial hypertext system, the **Hypercard**
 - Early 1980s - **Tim Berners-Lee**, a scientist at **CERN**, was developing his own idea of linked information (**CERN** is the European Laboratory for Particle Physics based in Geneva, Switzerland)

1/7/01 SFU, CMPT 470 20

- History (cont'd)
 - 1990
 - ARPANET decommissioned and ceases to exist
 - "world.std.com" becomes the world's first ISP
 - Internet toaster, the first remotely operated machine to be hooked up to the Internet
 - Cisco Systems goes public \$288 M
 - 1991
 - World Wide Web (WWW), developed by Tim Berners-Lee, released by CERN
 - PGP (Pretty Good Privacy) released by P. Zimmerman
 - NSFNET backbone upgraded to T3 (44.736 Mbps)

1/7/01 SFU, CMPT 470 21

- The Man Who Weaved the Web
 - Tim Berners-Lee (TBL)
 - "Hope in life comes from the interconnections among all the people in the world. We believe that if we all work for what we think individually is good, then we as a whole will achieve more power, more understanding, more harmony as we continue the journey."

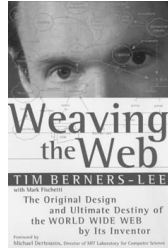

1/7/01 SFU, CMPT 470 22

- A. Vannever Bush and the Memex
 - Vannever Bush
 - Director of the Office of Scientific Research and Development (OSRD) during World War II.
 - Founded the National Science Foundation
 - Founded DARPA (Research arm within the Department of Defense.)



1/7/01 SFU, CMPT 470 23

- Artist's Rendition of Memex
 

1/7/01 SFU, CMPT 470 24

B. Ted Nelson and Xanadu

- Term "hypertext" was coined in 1965 by Ted Nelson (self-described "visionary")
- Check out Nelson's web site:
 - <http://www.sfc.keio.ac.jp/~ted/>



1/7/01

SFU, CMPT 470

25

History (cont'd)

- TBL's World Wide Web proposal (Word file)
- 1990 - The first Web browsing software (line-oriented, text-only) and a point-and-click browser ran on the NeXT computer
- 1991 - The WWW released for internal use at CERN
- 1992 - The WWW announced to the world and the software (browser and server) made publicly available

1/7/01

SFU, CMPT 470

26

History (cont'd)

- 1992
 - Number of Internet hosts breaks 1,000,000
 - First audio and video multicasts using MBONE
 - J.A. Polly coins the term "surfing the Internet"
- 1993
 - Internet Talk Radio begins broadcasting
 - Mosaic takes the Internet by storm; WWW traffic proliferates: Web grows by 341,000% in a year

1/7/01

SFU, CMPT 470

27

History (cont'd)

- **Feb 1993** - the US National Center for Supercomputing Applications (**NCSA**) released an early version of **Mosaic**
 - It was a big hit, and the Web took off explosively
 - Mosaic was developed by **Marc Andreessen** who was only an undergraduate student at the time when he started to work on the project
- 1994 - Marc and some of his colleagues left NCSA to found Mosaic Communications Corp. (now **Netscape**)
- 1994 - TBL left CERN for **MIT** to found the W3 Consortium (**W3C**)

1/7/01

SFU, CMPT 470

28

History (cont'd)

- 1994
 - Shopping malls arrive on the Internet
 - Pizzas can be ordered online from Pizza Hut
 - (1) FTP, (2) WWW, (3) Telnet generate the most traffic
- 1995
 - NSFNET reverts back to a research network
 - Sun launches Java on May 23
 - RealAudio comes online

1/7/01

SFU, CMPT 470

29

History (cont'd)

- 1995 (cont'd)
 - Netscape IPO
 - CompuServe, America Online, Prodigy begin to provide Internet access
 - Domain name registration for a fee
 - Technologies of the Year: WWW, search engines
- 1996
 - Internet phone poses a threat to telecommunication companies
 - Plans to add 7 new generic top-level domains announced
 - The browser war fought fiercely between Netscape and Microsoft

1/7/01

SFU, CMPT 470

30

History (cont'd)

- 1996 (cont'd)
 - Technologies of the Year: Search engines, Java, Internet phone
 - Emerging Technologies: Virtual environments (VRML), collaborative tools, Internet appliance (Network Computer)
- 1997
 - Amazon.com IPO
 - Technologies of the Year: Push, multicasting.
 - Emerging Technologies: Push, streaming media
- 1998
 - The 2 millionth domain registered on 4 May.
 - Electronic postage stamps become a reality

1/7/01 SFU, CMPT 470 31

History (cont'd)

- 1998 (cont'd)
 - Open Source software comes of age
 - Technologies of the Year: E-commerce, e-auctions, portals
 - Emerging Technologies: E-trade, XML, intrusion detection
- 1999
 - First Internet Bank of Indiana, the first full-service Net-only bank, opens for business
 - Technologies of the Year: E-trade, online banking, MP3

1/7/01 SFU, CMPT 470 32

History (cont'd)

- 2000
 - denial of service attack is launched against major web sites, including Yahoo, Amazon, and eBay in early February
 - Technologies of the Year: ASP, NAPSTER?, IPv6?
 - The Love Letter viruses (May) left many sites dumbfounded
- See also
 - [A brief history of the Internet](#)

1/7/01 SFU, CMPT 470 33

The WWW Consortium (W3C)

- The W3C develops interoperable technologies (specifications, guidelines, software, and tools) to lead the Web to its full potential as a forum for information, commerce, communication, and collective understanding



1/7/01 SFU, CMPT 470 34

Server-Side View

Database-driven content

Lots of Users

Scalability

Load balancing

Often implemented with cluster of PCs

24x7 Reliability

Transparent upgrades

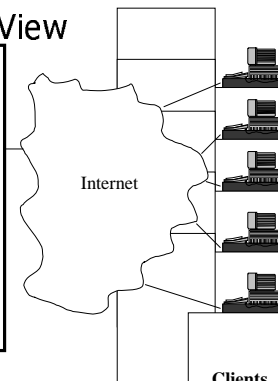

1/7/01 SFU, CMPT 470 35

Network View

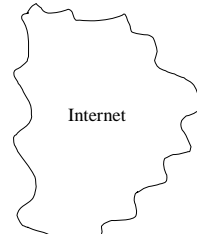

1/7/01 SFU, CMPT 470 36

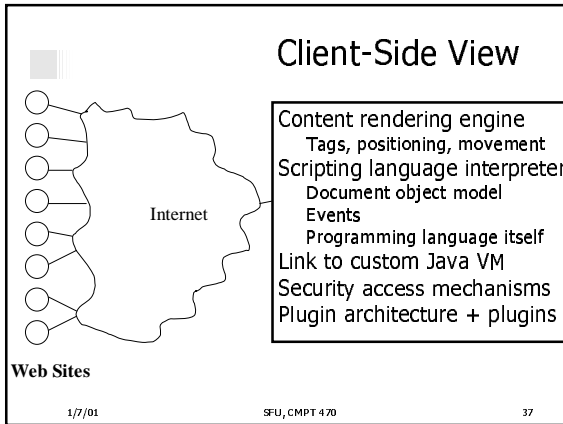

- ## Client-Side... Impact
- Many different browsers
 - {Netscape, IE, Lynx, ...} × Version × OS
 - Each supports different tags, DOM, languages...
 - Strategies:
 - Page branching
 - Internal branching (javascript control in each page)
 - Designing for the common denominator
 - Custom APIs with javascript libraries
- 1/7/01 SFU, CMPT 470 38